

MORI

manual

Electric tea
harvester

ETH-600



ISO 9001: 2000
Rev. 2021/05/10







Before using the electric tea picker, please read the following instructions carefully to ensure safe operation !

Contents

1. Symbol description and precautions
2. Safety rules
3. Technical Information
4. Installation instructions for spare parts
5. Basic Operation Instructions

6. Instructions for harvesting tea
7. Maintenance

1. Symbol description and precautions

	must read and follow the operation manual before use.
	Wear qualified and protective earmuffs and goggles
	Wear qualified and protective gloves
	Wear protective boots with strong and durable operation manual
	Do not touch the blade
	Do not use in rain or humid environment
	Must be charged and stored indoors in a dry and ventilated place
	Must store battery separately after usage from the equipment to avoid accidental touch or self-consumption of battery

2. Safety rules

Before using this machine

- *Please read the operation manual carefully.
- *Please check and maintain the machine in a flat place to avoid moving or dropping the machine.
- *Check the correct assembly and adjustment of the cutter.
- *Ensure that any failure has been repaired.
- *Check clothing and protective equipment (safety helmet, goggles, safety shoes, gloves, earplugs, etc.).
- *Do not touch the blade with bare hands (gloves should be worn).

Precautions

1. Check the work place carefully and confirm that there are no dangerous items.
2. Do not perform work on unstable foundations.
3. During the operation, be sure to keep bystanders or obstacles (wires, etc.) at least 5 meters away.
4. Do not use the electric tea harvester for other purposes.
5. During the operation, do not touch obstacles such as stones and metals.
6. Do not touch the blade, otherwise it will cause serious injury.
7. If a branch gets into the blade, be sure to turn off the power before removing the branch.
8. During transferring, carrying or storing the machine, the battery connection must be removed.
9. When moving or transporting, make sure to cover the cutting blade with the blade cover.
10. When using a vehicle to transport the product, please secure the machine to the vehicle to prevent it from tipping or falling.
11. When storing the machine, it needs to be thoroughly cleaned and maintained.
12. When storing the machine, if the machine is placed upright, it may cause accidental injury.
13. Ask your dealer or authorized agent for regular inspection and maintenance of the machine.

3. Technical information

Specification		
Item	One man tea harvester	
Model no.	ETH-600	
Vvoltage	36 VDC	
Weight (without battery)	4.6 kgs	
RPM (motor)	8500 /min	
Length	870 mm	
Length of blade	590 mm	
Continuous operating time	battery : 6.3Ah	30~40 minutes
Continuous operating time	battery : 25.2Ah	120 ~ 130 minutes
操作噪音	90 dB	



CAUTION

The above technical information will be different due to the different testing environment and will be with differences in datas.

4. Installation instructions for spare parts

Installation of leaf bag

The mesh of the leaf-collecting bag faces upwards, the lower half of the opening is stuffed into the sheet metal.

Use four bag hooks to fix, and tie the belt tightly to avoid leaf collecting bag (Figure 1) falling off.

Tie the other side of the leaf collection bag tightly to prevent the leaves from falling out.

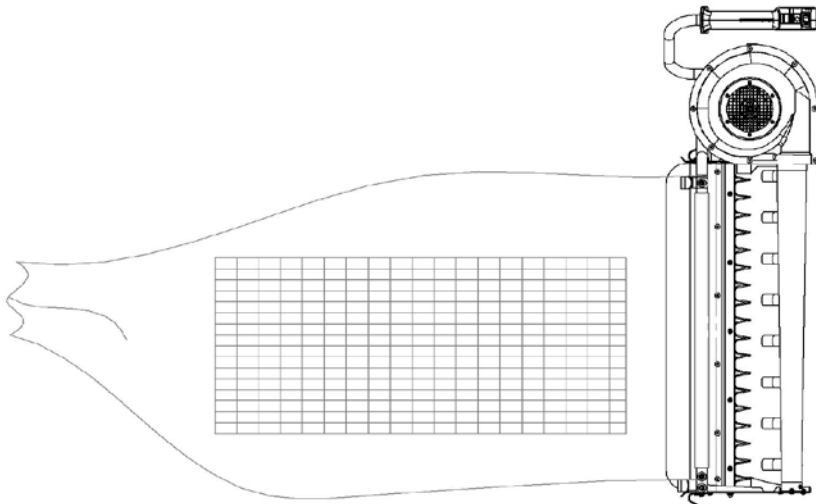

Figure 1



CAUTION

If the leaf collection bag is loose or too tight, adjust the strap at the opening of the bag. If too loosened, the leaf collecting bag may fall off the machine during work



CAUTION

Use leaf-collecting bags with mesh only

6. Basic operation instructions

1. connect the battery cable to the machine and tighten the nut (Figure 2).
2. turn on the power switch (Figure 3).
3. Press and hold the safety device to press the throttle lever.
4. The user can change the speed by using 2 speed switch
5. Please turn off the power switch during resting.
6. Must wear qualified & protective equipments during work
7. Must take out the battery and store it separately after works
9. Must fully charge the battery before storage.

Figure 2

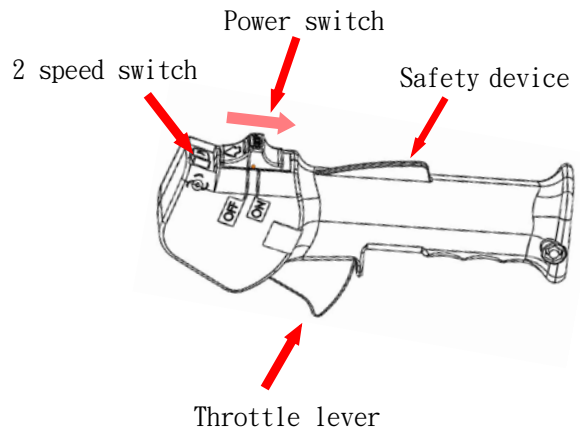
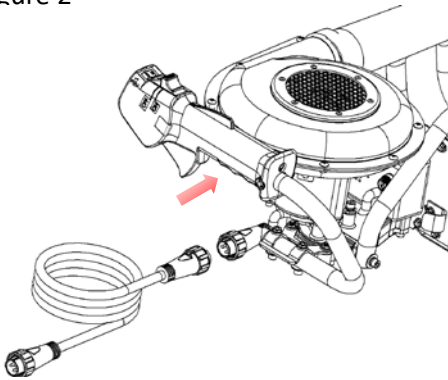

Figure 3



WARNING

Must check the machine and blade, if hit any object or stone



WARNING

Need to replace qualified parts and blade, as they might cause injury during operation



CAUTION

Must turn off the power and take out the battery during any maintenance works or repairs.



CAUTION

Need to fully charge the battery after works for future usage

8. Maintenance

For blade

1. Clean the blade with a clean cloth after usage.
2. Please use lubricating oil to lubricate the blade before and after each usage.



Please replace the blade, if the blade gap is too large to cut.

Adjustment of air hose

Please check the air hose is in the correct position If the picked leaves are blocked by the machine or have bad cutting sections

Note

- If a part of the air hose is pressed, it may deform or change its direction, so do not press it.
- If you find any abnormality, please contact the authorized dealer immediately for repair.

